

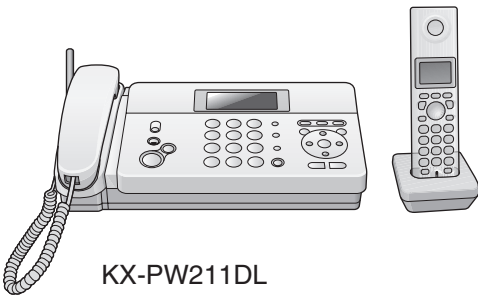

Facsimile

Quick Reference Guide



KX-PW211DL

Model No. **KX-PW211DL**

Main unit: KX-PW211
Portable handset: KX-FKN526

Thank you for purchasing a Panasonic facsimile.

Table of Contents

| | |
|---|----|
| Finding the controls | 2 |
| Installations and connections | 4 |
| Setting the date and time..... | 6 |
| Setting your facsimile telephone number | 6 |
| Setting your logo | 7 |
| Character input and command key table | 8 |
| Voice guide..... | 9 |
| Automatic dialing on the main unit | 10 |
| Automatic dialing on the portable handset (KX-FKN526) | 12 |
| Intercom | 13 |
| Sending faxes | 14 |
| Receiving faxes | 15 |
| Operating the built-in answering device | 16 |
| Night mode..... | 17 |
| Call block | 18 |
| Specifications | 19 |

- This guide explains some basic features and operations, but not all of them. For further details, see the Japanese operating instructions.
- This product is designed for use in Japan. Panasonic cannot provide service for this product if used outside Japan.
- Any details given in this guide are subject to change without notice.

This unit is equipped with the voice guide features. (Japanese only)
For details about voice guide, please see page 9.

Finding the controls

Main unit

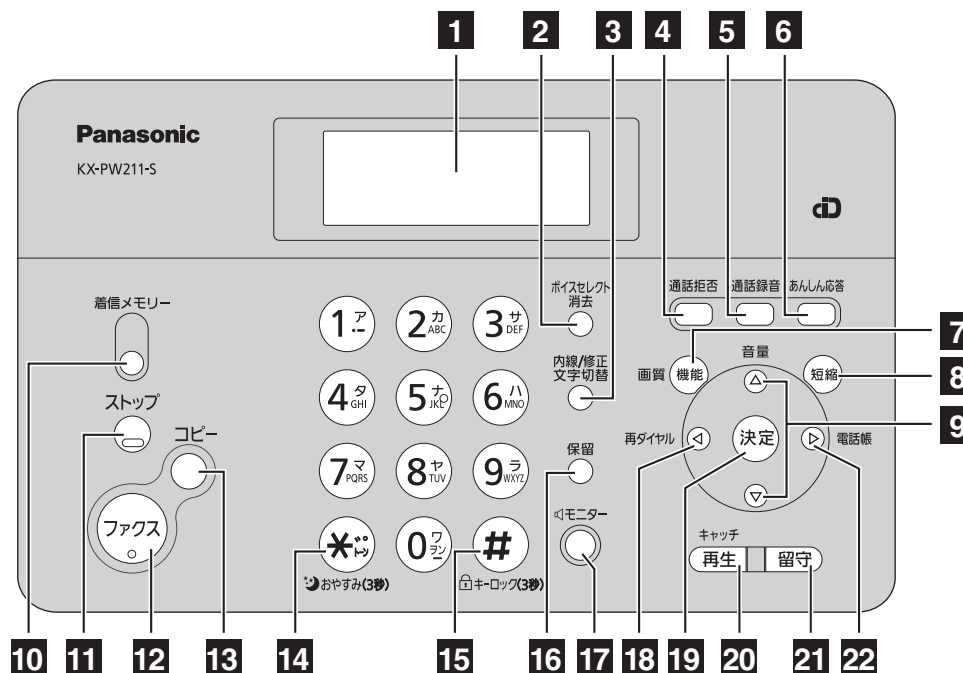















- 1 Liquid crystal display**
- 2 Voice select button**
Erase button
- 3 Intercom button**
Edit button
- 4 Block button for the undesired call**
- 5 Record button** records a telephone conversation.
- 6 Secure button**
While the unit is ringing, press this button. The unit announces a message to the caller. The message is announced in Japanese and means "This unit is currently set to Caller Verifying mode. Could you please speak out your name?".
 - To talk to the caller, lift the handset.
 - To hang up, press *****.
- 7 Function button** initiates programming.
Resolution button selects the resolution when faxing or copying.
- 8 Speed Dialer button**
- 9 Search buttons**
Volume buttons
 - To adjust the **ringer volume** when the unit is on stand by
 ▼ → ▼ (Select "コヒダシオウハンコウ") → 決定
 → ▼ ▲ (press repeatedly)
 - To adjust the **receiver volume** while talking, press ▼ ▲ repeatedly.
 - To adjust the **speaker volume** while listening to the recorded messages or using the monitor, press ▼ ▲ repeatedly.
- 10 Call Memory button** starts a search in the Number Display (Caller ID) log.
Call Memory indicator lights when a call was missed.
(For Number Display service users.)
- 11 Stop button**
- 12 Fax button** starts faxing.
- 13 Copy button** starts copying.
- 14 Tone button** switches to tone dialing.
Night mode button
- 15 Sharp button**
Key lock button can lock the main unit so that no calls or settings can be made. To turn key lock on, press this button for about 3 seconds until a single beep is heard.
 - "i" is displayed.
 - To turn key lock off, press this button for about 3 seconds.
- 16 Hold button**
- 17 Monitor button**
- 18 Redial button** redials the phone numbers in the redial list. The last 10 phone numbers dialed are stored in memory.
- 19 Set button** stores a parameter.
- 20 Playback button** plays back recorded messages.
Flash button (For call waiting service users.)
- 21 Auto Answer button & indicator**
—light on: answering device activated.
—light off: used as a regular telephone.
- 22 Phonebook button**

Finding the controls



Portable handset (KX-FKN526)

How to use key

-  **電話帳** ● To use the phonebook.
-  ● To redial the phone numbers in the redial list. The last 10 phone numbers dialed are stored in memory.
-  ● To adjust the volume.
 - To adjust the ringer volume when the portable handset is on stand by  →  (Select “ヨビ” “タシ” “オノリヨウ”) → 
 -  (press repeatedly)
- To adjust the receiver volume while talking, press  repeatedly
- To adjust the speaker volume while listening to the recorded messages or using the speakerphone, press  repeatedly

-  ● To make/answer calls.
-  ● To end a call.
● To end or exit from editing or other operations.
-  ● To put a call on hold.
 ● To start a search in the Number Display log. (For Number Display service users.)
-  ● To page the main unit and/or portable handset(s).
● To change the character input mode.

Dial buttons

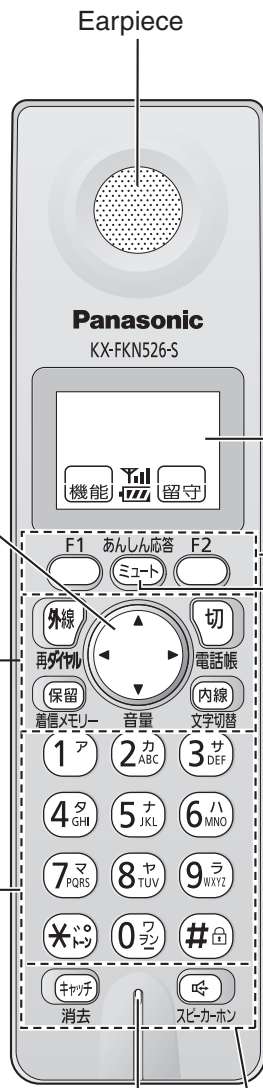

-  **Tone button**
 - To switch to tone dialing.
-  **Sharp button**
Key lock button
 - To lock the portable handset so that no calls or settings can be made. To turn key lock on, press this button for about 3 seconds until a single beep is heard.
 - To turn key lock off, press this button for about 3 seconds until a single beep is heard.



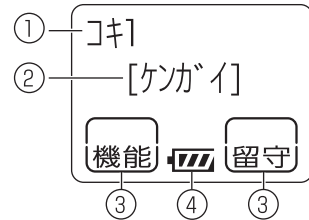

Microphone
(Do not cover the microphone while talking.)

Liquid crystal display





- ① Portable handset number (and name)
- ② No link to the main unit
- ③ Function menu that is controlled by  or 
- ④ Battery strength

How to use buttons

 and  buttons refer to the function displayed on the bottom of the display. They function differently depending on the mode.

あんしん応答

- Secure button**
 - While the portable handset is ringing, press this button. The portable handset announces a message to the caller. The message is announced in Japanese and means “This unit is currently set to Caller Verifying mode. Could you please speak out your name?”.

- To talk to the caller, press .
- To hung up, press .

Mute button

- To mute your voice to the other party by pressing this button. (To release the mute, press this button again.)

キヤッチ

- For call waiting service users.

消去

- To clear letters/numbers.

スピーカホン

- To use the speakerphone.

Installations and connections

Connecting the main unit

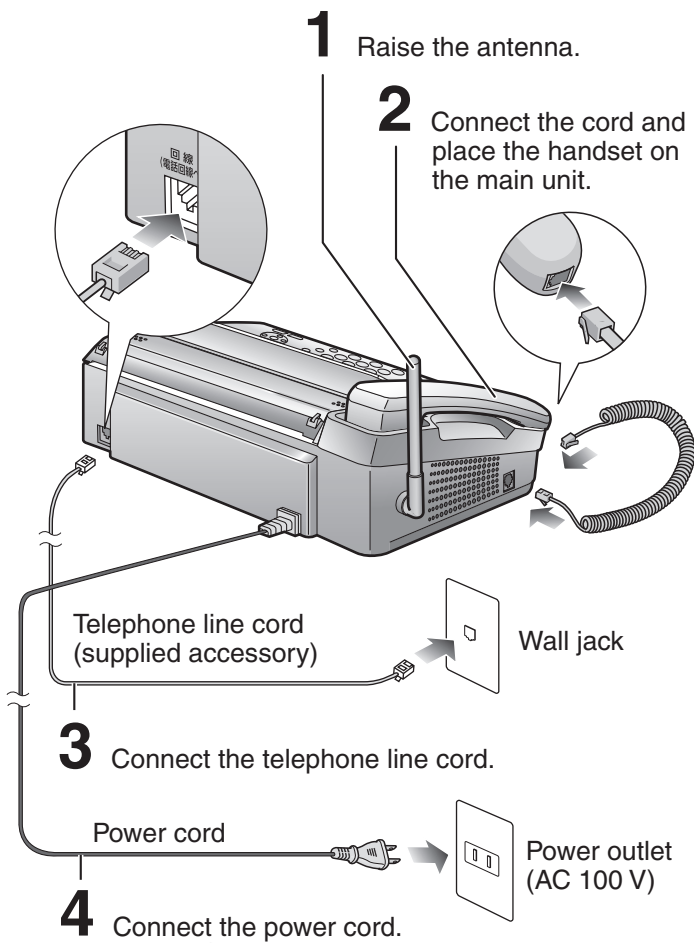

After the Power On...

- ① This unit will automatically select the dialing mode (Pulse/Tone).
- ② When the following is displayed, press **ストップ** (Stop).

エラソテ ケータイノセツテイ
[ケツテイ]オス

If you cannot make a call...

Set the dialing mode with the main unit.

1. Press **機能** (Function).
2. Press **# 0 7 9**.
3. Press **◀ ▶** (Search button) repeatedly until the desired setting is selected.

Example :

カイセンシユハツ=ジトドウ
[◀▶]→[ケツテイ]オス

- アツシユ : Tone
- 20 : Pulse (20 PPS)
- 10 : Pulse (10 PPS)
- ジトドウ : Auto (Default)

4. Press **決定** (Set).
5. Press **ストップ** (Stop).

Setting up the portable handset (KX-FKN526)

- 1 Press **☰** on the battery cover and slide the cover.

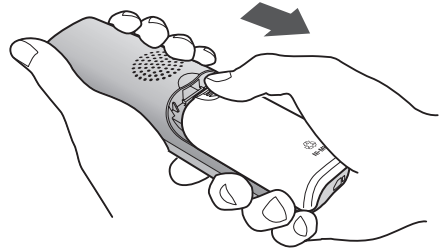

- 2 Insert the battery into the compartment and close the battery cover.

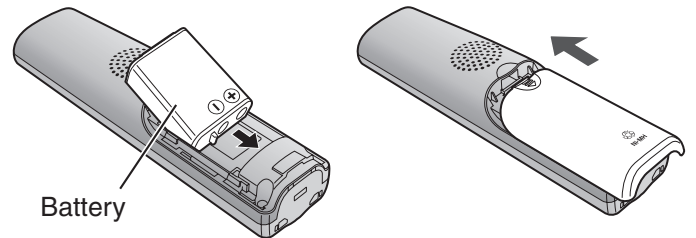

- 3 Connect the charger to the power outlet, then place the portable handset on the charger for about **10 hours**.

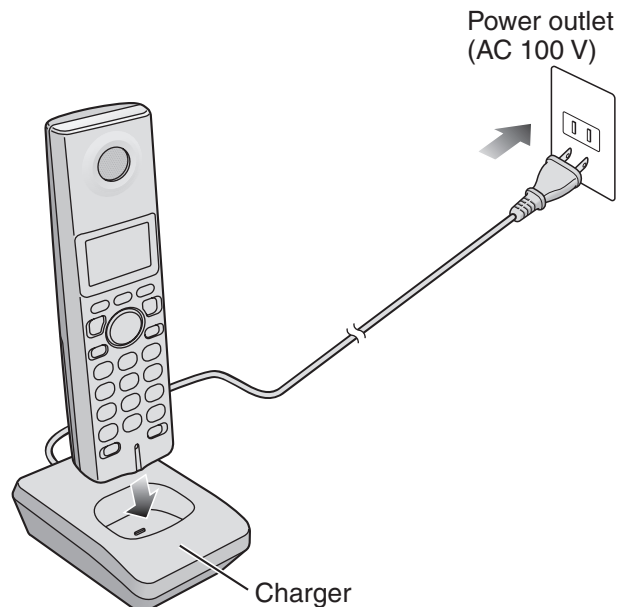

- After your Panasonic battery is fully charged, it will last up to about 5 hours of conversation.

Installations and connections

Installing the thermal recording paper

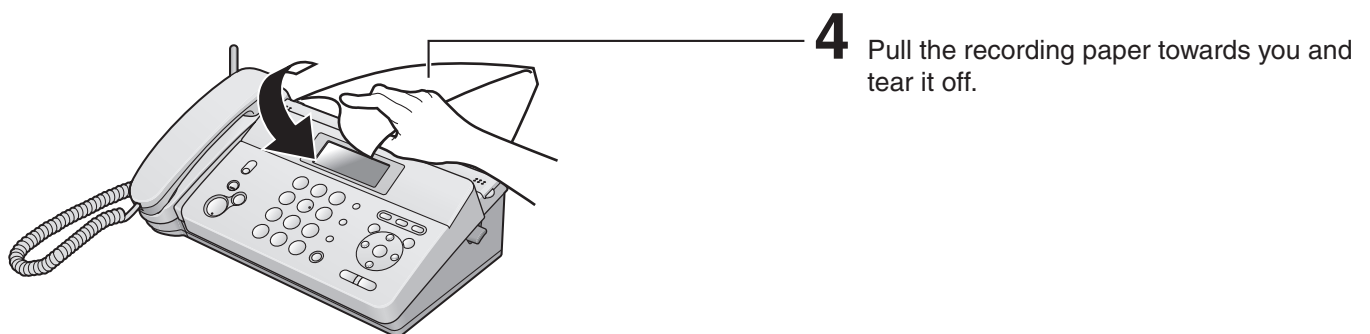
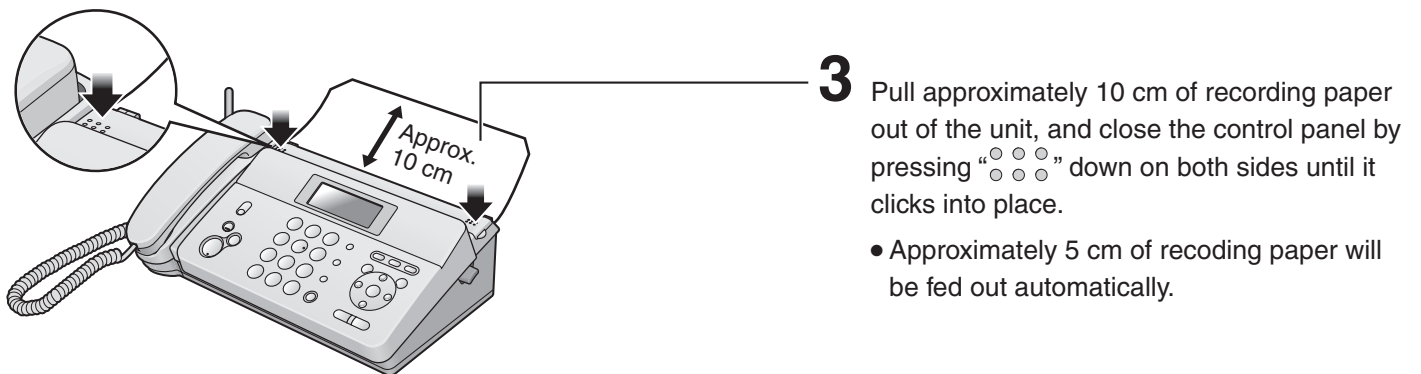
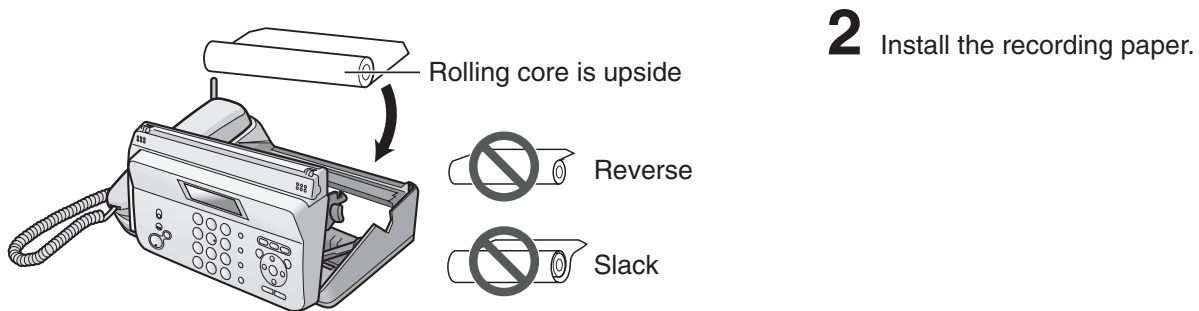
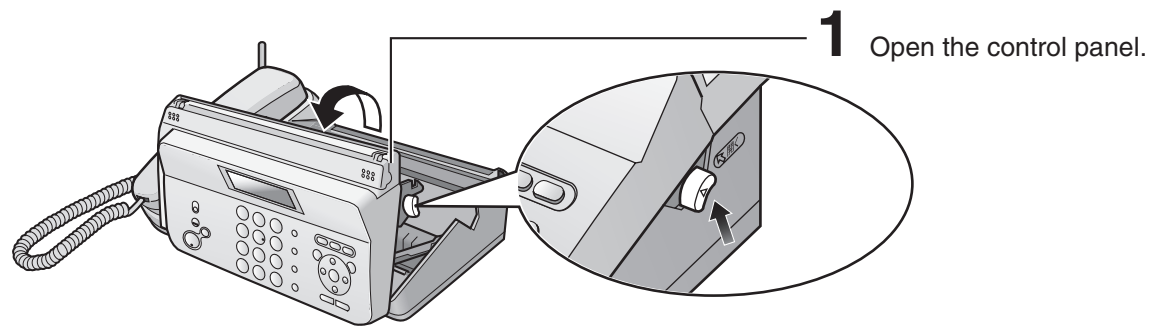

- When the unit runs out thermal recording paper, the following message will be displayed.

| | | |
|---|---|---------------------------------------|
| キロクシカ [®] アリマセン U20 カミヨ イレテクダ [®] サイ | ↔ | スイショウヒンバ [®] ツ: UG-0010A4 |
|---|---|---------------------------------------|

Install a new thermal recording paper.

Replacement thermal recording paper:
UG-0010A4 (15 m role type) ¥473

· As of September 2008. · Tax included.

Setting the date and time

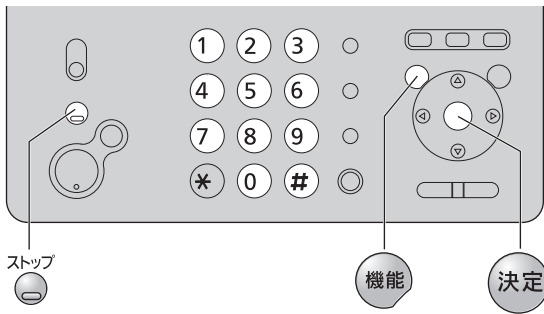

1 Press **機能** (Function).

キノウ トウロク モード
[▼,▲]オス

2 Press **# 0 0 1**.

Example :

2008年11月30日
15:00
Cursor

3 Enter the correct year/month/day.

Example: December 1, 2008

Press **2 0 0 8 1 2 0 1**.

2008年12月01日
15:00

4 Enter the correct hour/minute in a 24-hour clock entry.

Example: 15:45 (3:45 PM)

Press **1 5 4 5**.

2008年12月01日
15:45

5 Press **決定** (Set).

トウロク シマシタ



2008年12月01日
15:45

6 Press **ストップ** (Stop).

Example :

12月 1日 15:45
ヨウケン ロクオン 0ケン

Setting your facsimile telephone number

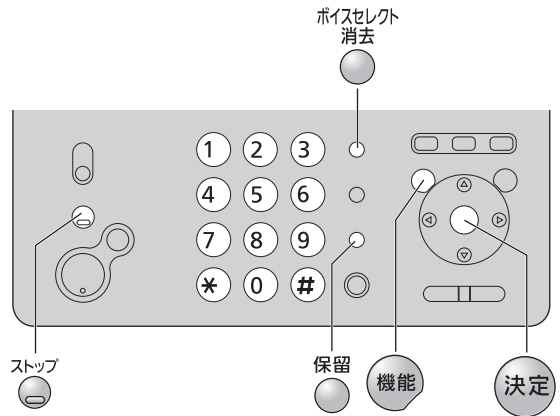

1 Press **機能** (Function).

キノウ トウロク モード
[▼,▲]オス

2 Press **# 0 0 4**.

アナタデ ノワ バン コウ?
.....

3 Enter your facsimile telephone number, up to 20 digits.

Example: +098 7654..

アナタデ ノワ バン コウ?
+098 7654.....

• To correct a mistake, press **ボイスセレクト 消去** (Voice select/Erase).



• The **保留** (Hold) button replaces the digit with a space.



• The *** (Tone)** button replaces the digit with "+".

4 Press **決定** (Set).

トウロク シマシタ



アナタデ ノワ バン コウ?
+098 7654.....

5 Press **ストップ** (Stop).

Example :

12月 1日 15:45
ヨウケン ロクオン 0ケン

Setting your logo

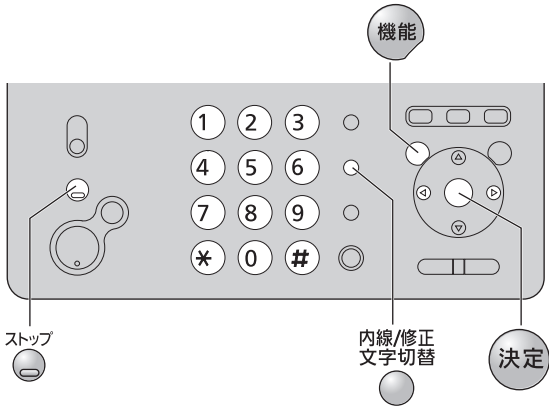

1 Press **機能** (Function).

キノウ トウロク モード
[▼,▲]オス

2 Press **# 0 0 2**.

アナタノナマイ? [カナ]
Cursor

3 Enter your logo, up to 30 characters, using the dial keypad.

- To enter English characters easily, press **内線/修正 文字切替** (Intercom / Edit / Character input mode) repeatedly and select "AB" (English and sign input mode).
- For details, see the table on page 8 for instructions.

Example: Micah

1. Press **6** once.

アナタノナマイ? [AB]
M
Cursor

2. Press **4** six times.

アナタノナマイ? [AB]
Mi

3. Press **2** six times.

アナタノナマイ? [AB]
Mic

4. Press **▶** to move the cursor to the next space, then press **2** four times.

アナタノナマイ? [AB]
Mica

5. Press **4** five times.

アナタノナマイ? [AB]
Micah

4 Press **決定** (Set).

トウロク シマシタ
↓
アナタノナマイ? [カナ]
Micah









5 Press **ストップ** (Stop).

Example :

12月 18 15:45
ヨウケン ロクオン 0ケン

Character input and command key table

Pressing the dial keys will select a character as shown below.



| Character | | Katakana | English and signs | Numbers |
|---|-----------------------------------|---|--|--|
| Display of the main unit and the portable handset | | [カ] | [AB] | [12] |
| Dial key | | | | |
| (Main unit) ① | (Portable handset KX-FKN526) ① | アイウエオ アイウエオ | @ . _ - & \$ ¥ % + = ~ ^ | 1 |
| ② | ② | カキクケコ | A B C a b c | 2 |
| ③ | ③ | サシスセソ | D E F d e f | 3 |
| ④ | ④ | タチツテトツ | G H I g h i | 4 |
| ⑤ | ⑤ | ナニヌネノ | J K L j k l | 5 |
| ⑥ | ⑥ | ハヒフヘホ | M N O m n o | 6 |
| ⑦ | ⑦ | マミムメモ | P Q R S p q r s | 7 |
| ⑧ | ⑧ | ヤユヨヤユヨ | T U V t u v | 8 |
| ⑨ | ⑨ | ラリルレロ | W X Y Z w x y z | 9 |
| ⑩ | ⑩ | ワヲンー!?() | ! ? / - * # , ; : · ' " () [] { } < > 「 」 | 0 |
| * | * | ゝ っ っ っ | 、 。 | |
| Command keys | | 内線/修正 文字切替  (Main unit), | 内線 文字切替  (Portable handset) | Used to change the character input mode. |
| | |  (Main unit) |  (Portable handset) | Used to move the cursor to the left and right. |
| | | ボイスセレクト 消去  (Main unit), | キャッチ 消去  (Portable handset) | Used to delete a character. |
| | | 保留  (Main unit), | 保留  (Portable handset) | Used to insert a space. |

- The characters on the display are somewhat different from those shown in the character input and command key table.

Voice guide

Operation guide

The unit starts the following voice guidance in Japanese:

| Operations | To cancel the operation guide (using the main unit) |
|---|--|
| Send a fax |  |
| Copy | |
| Add entries to the phonebook |  |
| Store phonebook entries in the speed dialer | |
| Make a call using the phonebook/redial/speed dialer/call memory | |
| Print fax documents from the main unit memory |  |

Reading-out dial

The unit announces the number dialed in Japanese, when you make a call with the main unit.

• To cancel the reading-out dial



Automatic dialing on the main unit

Storing names and telephone numbers in the phonebook

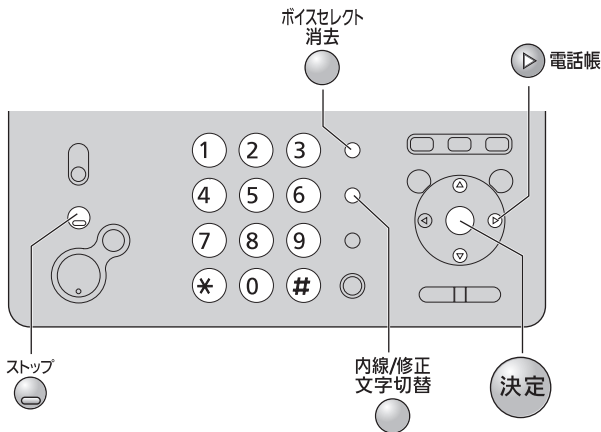

1 Press 電話帳 (Phonebook).

2 Press 決定 (Set).

- "XXX" shows the remaining station numbers you can store.
- You can program up to 150 stations, including 4 pre-programmed stations.

デモンワチョウ アキXXXXケン

3 Enter the name, up to 12 characters (see the table on page 8 for instructions).

4 Press 決定 (Set).

5 Enter the telephone number, up to 24 digits.

- To correct a mistake, press ボイスセレクト 消去 (Erase).

6 Press 決定 (Set).

7 Enter the group number (① to ⑨).

8 Press 決定 (Set).

- To program other items, repeat steps 3 to 8.

9 Press ストップ (Stop) to exit the program.

Making a voice call using the phonebook

1 Press 電話帳 (Phonebook).

2 Press (Search button) repeatedly until the desired name is displayed.

3 Lift the handset.

Editing a stored name or number in the phonebook

1 Press 電話帳 (Phonebook).

2 Press (Search button) repeatedly until the desired name is displayed.

3 Press 内線/修正 文字切替 (Intercom/Edit/Character input mode).

4 Edit the name (see the table on page 8 for instructions).

- If you do not need to edit the name, skip to step 5.

5 Press 決定 (Set).

6 Edit the telephone number.

- If you do not need to edit the telephone number, skip to step 7.

7 Press 決定 (Set).

8 Edit the group number.

- If you do not need to edit the group number, skip to step 9.

9 Press 決定 (Set).

10 Press ストップ (Stop).

Automatic dialing on the main unit

Storing names and telephone numbers in the speed dialer

You can store up to 9 names and telephone numbers which are stored in the phonebook. The dialing buttons (1 to 9) function as memory stations.

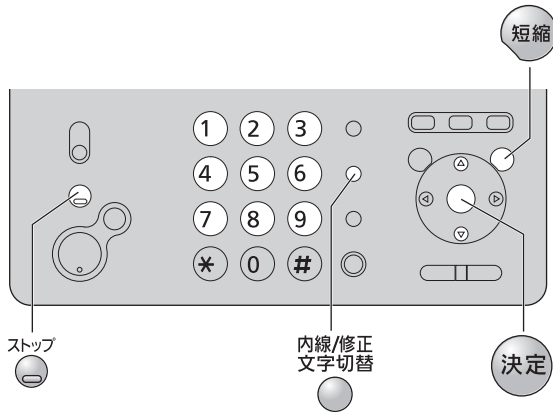

1 Press **短縮** (Speed dialer).

2 Press the memory station number (1 to 9).

Example: speed dialer 1

1. ミトウロク
トウロクハ [シュウセイ] オス
Memory station number

3 Press **内線/修正文字切替** (Intercom/Edit/Character input mode).

4 Press **▽** **△** (Search button) repeatedly until the desired name is displayed.

5 Press **決定** (Set).

• To program other items, repeat steps 2 to 5.

6 Press **ストップ** (Stop) to exit the program.

Making a voice call using the speed dialer

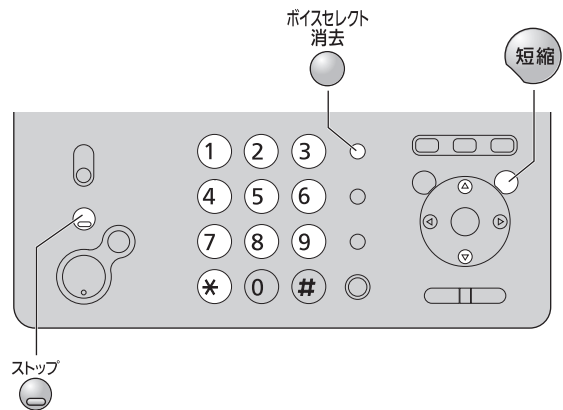

1 Press **短縮** (Speed dialer).

2 Press the memory station number (1 to 9).

3 Lift the handset.

Erasing a stored name and number in the speed dialer

1 Press **短縮** (Speed dialer).

2 Press the memory station number (1 to 9).

3 Press **ボイスセレクト消去** (Voice select / Erase), then press *****.

4 Press **ストップ** (Stop) to exit the program.

Automatic dialing on the portable handset (KX-FKN526)

Storing names and telephone numbers in the phonebook

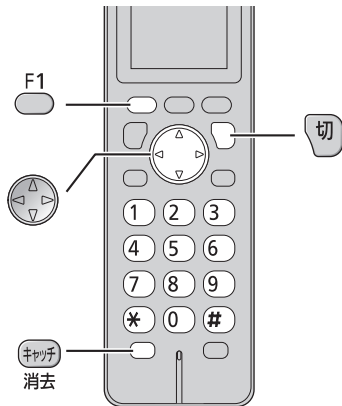

1 Press 電話帳 (Phonebook).

ケンサクハ[▼,▲]オス
トウロクハ[F1]オス

2 Press .

- “XXX” shows the remaining station numbers you can store.
- You can program up to 150 stations, including 4 pre-programmed stations.

ナマエ? [カナ]
アキ XXXケン

3 Enter the name, up to 12 characters (see the table on page 8 for instructions).

4 Press .

5 Enter the telephone number, up to 24 digits.

- To correct a mistake, press (Flash/Erase).

6 Press .

7 Enter the group number (1 to 9).

8 Press .

- To program other items, repeat steps 3 to 8.

9 Press (Off) to exit the program.

Making a voice call using the phonebook

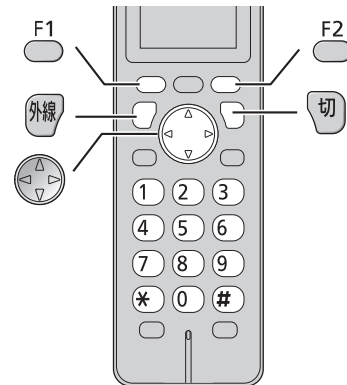

1 Press 電話帳 (Phonebook).

2 Press (Search button) repeatedly until the desired name is displayed.

3 Press (Talk).

Editing a stored name or number in the phonebook

1 Press 電話帳 (Phonebook).

2 Press (Search button) repeatedly until the desired name is displayed.

3 Press .

4 Edit the name (see the table on page 9 for instructions).

- If you do not need to edit the name, skip to step 5.

5 Press .

6 Enter the correct telephone number.

- If you do not need to edit the telephone number, skip to step 7.

7 Press .

8 Edit the group number.

- If you do not need to edit the group number, skip to step 9.

9 Press .

10 Press (Off) to exit the program.

Intercom

An intercom is available between the portable handsets or between the main unit and portable handset(s).

Using the main unit:

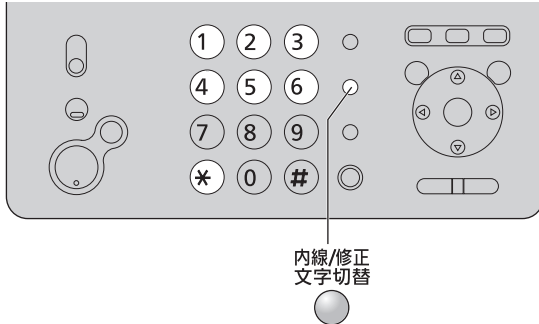

1 ■ For single portable handset users

- ① Lift the handset.

デシバツゴウ?

- ② Press 内線/修正
文字切替 (Intercom).

コキヨヒダシチュウ

■ For multiple portable handset users

- ① Lift the handset.

- ② Press 内線/修正
文字切替 (Intercom).

- ③ Call the portable handset(s) in the following ways:

- To call a specific portable handset, press the portable handset number (1 to 6) which you want to call.
- To call all the portable handsets, press (*).

2 Start talking.

Example : コキナイツウワ チュウ

3 Replace the handset to end the intercom call.

Using the portable handset (KX-FKN526):

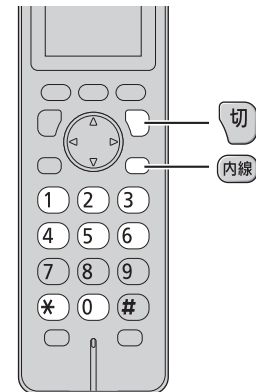

1 ■ For single portable handset users

- Press 内線 (Intercom).

■ For multiple portable handset users

- ① Press 内線 (Intercom).

- ② Call the main unit and/or portable handset(s) in the following ways:

- To call a specific portable handset, press the portable handset number (1 to 6) which you want to call.
- To call the main unit, press 0.
- To call the main unit and all the portable handsets, press (*).

2 Start talking.

ナイツウワ チュウ

3 Press 切 (Off) to end the intercom call.

Sending faxes

Sending a fax manually

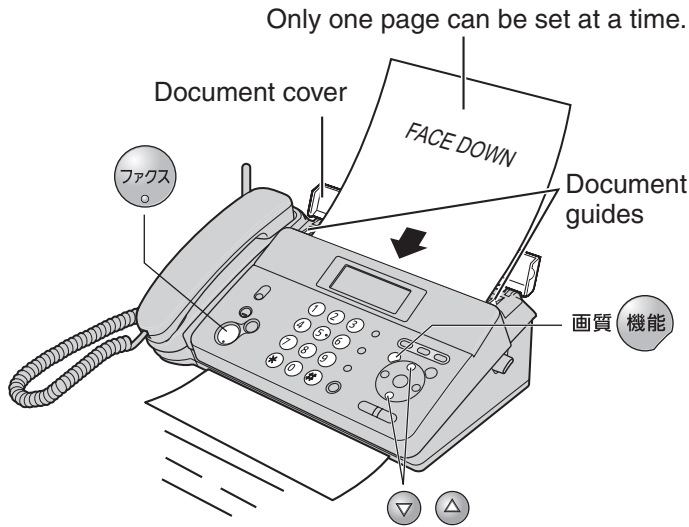

- 1** Open the document cover, and adjust the width of the document guides to the size of the document.
- 2** Insert the document (1 page only) FACE DOWN until a single beep is heard.
- 3** If necessary, press (Search button) repeatedly to select the desired resolution while “カ シツ=” is displayed (see below).
- 4** Press (Fax).
- 5** Dial the fax number.
- 6** Press (Fax).
 - The unit will start fax transmission.
 - After a page is scanned, 2 short beeps will sound, and

| |
|--------------------------|
| ツキ ノケ ソウワ イレ テ ク タ サイ |
|--------------------------|

 will be displayed for about 4 seconds. To send 2 or more pages, set the next page into place while this message is displayed.

To select the resolution

Select the desired resolution according to the type of document, by pressing repeatedly while “カ シツ=” is displayed.

To display “カ シツ=”, press (Function/Resolution) once or twice.

| |
|-----------|
| カ シツ=フツウシ |
|-----------|

 (Standard) for printed or typewritten originals with normal-sized characters.

| |
|-----------|
| カ シツ=チイサイ |
|-----------|

 (Fine) for originals with minute printing.

| |
|----------|
| カ シツ=シャシ |
|----------|

 (Photo) for originals containing photographs.

Sending a fax using automatic dialing

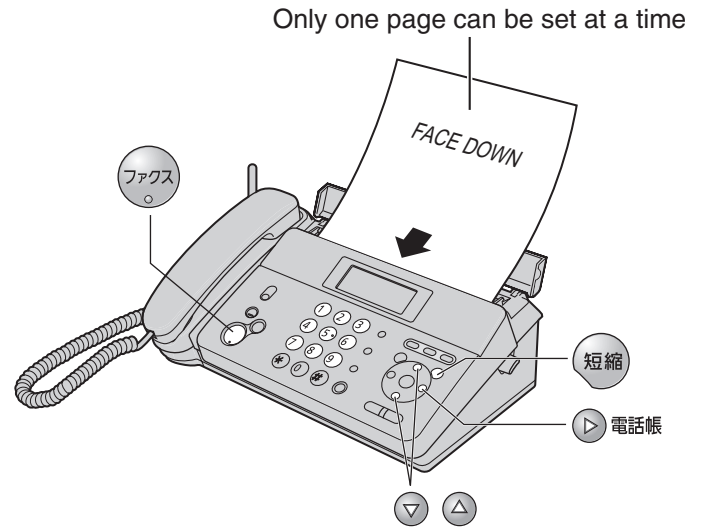

Using the phonebook

- 1** Insert the document (1 page only) FACE DOWN until a single beep is heard.
- 2** Press (Phonebook).
- 3** Press (Search button) repeatedly until the desired name is displayed.
- 4** Press (Fax).
 - The unit will start fax transmission.

Using the speed dialer

- 1** Insert the document (1 page only) FACE DOWN until a single beep is heard.
- 2** Press (Speed dialer).
- 3** Press the memory station number (to).
- 4** Press (Fax).
 - The unit will start fax transmission.

Receiving faxes

Receiving a fax manually (AUTO ANSWER off)

Using the main unit:

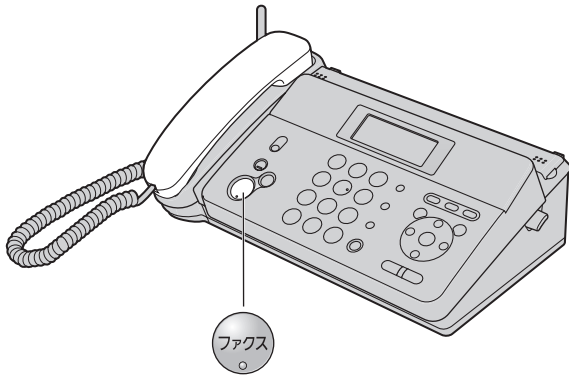



1 When you hear a ring, lift the handset to answer the call.

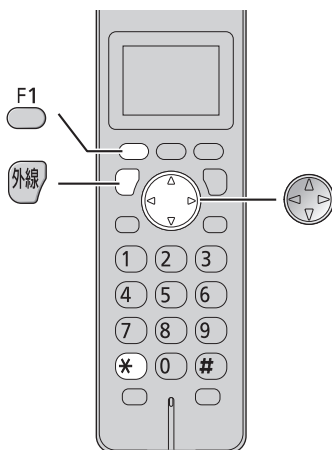

2 When:
– document reception is required,
– a fax calling tone (slow beep) is heard, or
– no sound is heard,
press  (Fax), then replace the handset.
• The unit will start fax reception.

Using the portable handset (KX-FKN526):



1 When you hear a ring, lift the portable handset from the charger, then press  (Talk) to answer the call.

2 When:
– document reception is required,
– a fax calling tone (slow beep) is heard, or
– no sound is heard,
press .



3 Press  (Search button) repeatedly until the “ファクス シ ユジン” is displayed, then press .

4 Press .

- The main unit will start fax reception.

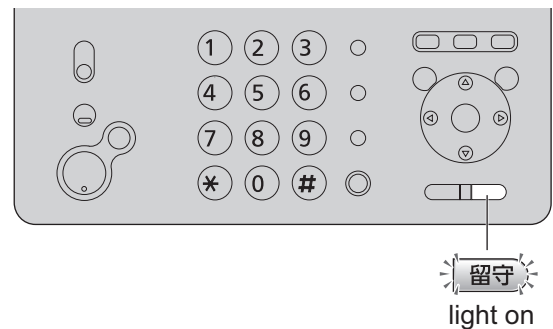
Receiving a fax automatically (AUTO ANSWER on)



1 If the  (Auto answer) light is off, turn it on by pressing .

2 When receiving a call, the unit will receive a fax document or record a voice message automatically depending on the caller's request.

Operating the built-in answering device

Recording your own greeting message

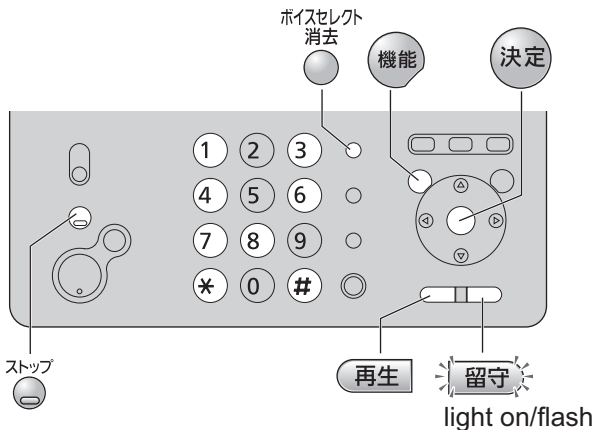

You can record your own greeting message. When receiving a call, it will be played to callers instead of the pre-recorded Japanese greeting message.

1 Press **機能** (Function).

2 Press **# 1 4 7**.

ジ サク オウトウ ロクオン
[ケツテイ]オス

3 Press **決定** (Set).

4 Lift the handset.

5 Press **決定** (Set) and speak your greeting message after a beep, up to 16 seconds, to the handset.

6 Press **ストップ** (Stop) and replace the handset.
• Your greeting message will be played back automatically.

Erasing your own greeting message

1 Press **機能** (Function).

2 Press **# 1 4 8**.

ジ サク オウトウ ショウキョ
[ケツテイ]オス

3 Press **決定** (Set).

4 Press *****.
• The pre-recorded Japanese greeting message will be played when you receive a call.

Activating the answering device

1 Turn the **留守** (Auto answer) light on by pressing **留守**.

2 When receiving a call, a greeting message will be played and the unit will record a voice message.
• To record your own greeting message, see left.

Listening to recorded messages

When new messages are recorded, the **留守** (Auto answer) light will flash.

Press **留守** to listen to recorded messages.

After the messages are played back, the following will be displayed.

■ To erase the messages, press *****.

サイセイシタヨウケンシヨウキョ
スル=* シナイ=#

■ To save the messages, press **#**.

Listening to all of the recorded messages

Press **再生** (Playback) when new messages are not recorded.

• When new messages are recorded, only the new messages will be played back.

After all of the recorded messages are played back, the following will be displayed.

■ To erase the messages, press *****.

スハ`テ ショウキョシマスカ?
ハイ=* イイエ=#

■ To save the messages, press **#**.

Erasing a specific message

Press **ボイスセレクト 消去** (Voice select/Erase) while listening to the message you want to erase, then press *****.

Erasing all of the recorded messages

1 Press **機能** (Function).

2 Press **# 1 6 3**.

ヨウケン ゼンシヨウキョ
[ケツテイ]オス

3 Press **決定** (Set).

4 Press *****.

Operating the built-in answering device

Operating the answering device from a remote location

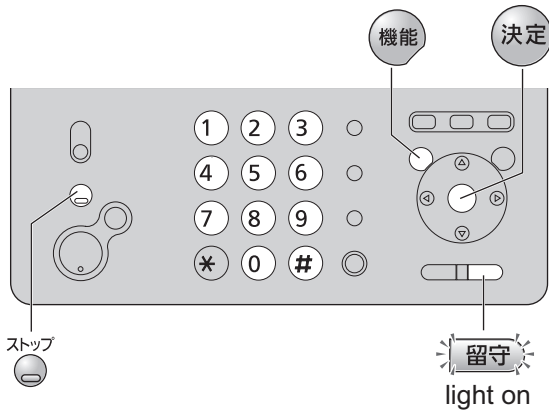

Preparation: Programming the remote operation ID

1. Press **機能** (Function).
2. Press **# 0 0 6**.
3. Enter any 4-digit number (remote operation ID) except * or #.

Example : アンショウ No. = 1234
[4ケタ] → [ケツテイ] オス

4. Press **決定** (Set).
5. Press **ストップ** (Stop).

Operation: Listening to a recorded message from a remote location

Turn the **留守** (Auto answer) light on before you go out.

Remote operations are available only from a touch tone telephone.

1. Call your unit.
2. Enter the remote operation ID during the greeting message.
3. Press **2** or wait 4 seconds.
 - Only the new recorded messages will be played back.
 - To listen to all the recorded messages, press **4** after the new messages have been played back.

Night mode

Turn on the night mode



Press ***** (Night mode) for about 3 seconds.

- “**” is displayed and **留守** lights on.
- When a call is received during night mode, the unit will handle the call silently, either by storing the received fax into memory or by recording the caller's message.
- Night mode allows you to select a block of time during which the unit will not ring for outside calls or make sounds when you change the settings. This feature is useful when you do not want to be disturbed, for example, while sleeping.

Listening to recorded messages

When new messages are recorded, the following will be displayed.

アタラシイ ヨウケンカ
ロクオン サラマシタ

Press **再生** (Playback) to listen to recorded messages.

After the messages are played back, the following will be displayed.

■ To erase the messages, press *****.

サイセイシタヨウケンシヨウキョ
スル=* シナイ=#

■ To save the messages, press **#**.

Printing received fax documents

When new faxes are received, the following will be displayed.

ファクスガ トトイテイマス
インザツ ハ [ケツテイ] オス

Press **決定** (Set) 2 times to print fax documents.

Turn off the night mode

Press ***** (Night mode) for about 3 seconds.

Blocking the incoming calls



Using the main unit:



To block a call using a message

While the unit is ringing, press  (Block).

OR

While you are on an incoming call, press  (Block), then press .

- The unit announces a message to the caller 2 times, then hangs up automatically. The message is announced in Japanese and means “We’re sorry, but your call cannot be connected.”.

To block a call using chimes

1 While you are on an incoming call, press  (Block).

2 Press .

- Chimes are heard by the caller.

3 Tell the caller that a visitor has come and hang up.

For Number Display service subscribers

If you subscribe to Number Display service, the message heard by the caller will change according to the caller’s situation.

Example :

If the caller requested not to send caller’s information, the message heard by the caller will change to mean
 “Your phone number is blocked by service provider.
 Please call again with adding ‘186’ to the beginning of the phone number.”.

When the following is displayed after pressing  (Block), you can set the unit to block the call from the same telephone number.

■ To block the call, press .

メイワク セツテイ シマスカ?
ハイ=* イイエ=#

■ To cancel blocking, press .

● When the following is displayed, press  to cancel.

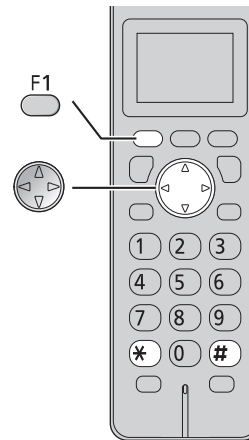

キヨビ セツテイ シマスカ?
ハイ=* イイエ=#

Using the portable handset (KX-FKN526):



1 While the unit is ringing, press .

OR

While you are on an incoming call, press , then press  (Search button) repeatedly until the “ツウワ キヨビ” is displayed.

2 Press .

- The unit announces a message to the caller 2 times, then hangs up automatically. The message is announced in Japanese and means “We’re sorry, but your call cannot be connected.”.

For Number Display service subscribers

If you subscribe to Number Display service, the message heard by the caller will change according to the caller’s situation.

Example :

If the caller requested not to send caller’s information, the message heard by the caller will change to mean
 “Your phone number is blocked by service provider.
 Please call again with adding ‘186’ to the beginning of the phone number.”.

When the following is displayed after operating step 1 and 2, you can set the unit to block the call from the same telephone number.

■ To block the call, press .

メイワク セツテイ?
ハイ=* イイエ=#

■ To cancel blocking, press .

● When the following is displayed, press  to cancel.

キヨビ セツテイ?
ハイ=* イイエ=#

Specifications

| KX-PW211DL | Main unit | Portable handset (KX-FKN526) | Battery charger |
|-------------------------------|---|---|--|
| Power supply | AC 100 V (50 Hz/60 Hz) | Ni-MH battery (Part no. KX-FAN51) DC 3.6 V, 650 mAh | AC 100 V (50 Hz/60 Hz) |
| Power consumption | Transmission: Approx. 12 W Reception: Approx. 22 W Copy: Approx. 18 W Stand by: Approx. 0.7 W (When the F-net service is not in use.) Maximum(*1): Approx. 130 W | | <ul style="list-style-type: none"> • Charging: Approx. 1.2 W • Stand by: Approx. 0.5 W (When the portable handset is off the charger.) |
| Dimensions (H x W x D) | Approx. 107 X 290 X 191 mm (without handset, projections) | Approx. 171 X 44.5 X 33.5 mm | Approx. 34 X 72.5 X 100.5 mm |
| Mass (Weight) | Approx. 2.4 kg (10 m recording paper installed) | Approx. 157 g (battery installed) | Approx. 160 g |
| Operating environment | 5 °C – 35 °C, 45 % – 85 % RH (Relative Humidity) | | |

| KX-PW211DL | Main unit |
|--------------------------------|--|
| Applicable line | Public Switch Telephone Network (Pulse/Tone), F-Net, NCC Lines |
| DC resistance | 275 Ω |
| Compatibility | G3 compatible |
| Document size | A4–A5 (Max. 210 mm in width, Max. 600 mm in length) |
| Effective scanning size | 208 mm (A4) |
| Effective printing size | 202 mm |
| Transmission time | Approx. 15 s/page (Original mode) (*2) |
| Modem speed | 9,600 / 7,200 / 4,800 / 2,400 bps; Automatic fallback |
| Halftone level | 64-level |
| Scanning density | Horizontal: 8 pels/mm Vertical : 7.7 lines/mm (Fine/Photo), 3.85 lines/mm (Standard) |
| Scanner type | Contact image sensor |
| Printer type | Thermal printing |
| Data compression system | Modified Huffman (MH), Original mode |
| Recording paper size | Thermal paper (Role type) A4: 210 mm x 15 m (Spindle diameter : approx. 1/2".) |
| Answering device | Greeting message: Digital recording system (up to 16 sec) Pre-recording greeting message ICM Recording: Digital recording system (Approx. 12 min. in total) (*3) |
| Memory capacity | Max. Approx. 50 pages (Only receiving fax etc.) (*4) Max. Approx. 12 min. (Only recording message) (*3) |

*1 When copying a 100 % black document.

*2 Transmission speed is based on an A4-size document of 700 characters sent in standard resolution at 9,600 bps. The actual transmission speed depends upon the contents of the page, resolution, telephone line conditions and capability of the other party's machine.

*3 If there is a silent pause, the total recording time will be longer.

*4 The memory capacity is based on an A4-size document of 700 characters sent in standard resolution (8 x 3.85 lines/mm).

